



**SC Klaipėdos nafta
results for the 1st quarter
2016**

3th May 2016



- ❖ INFORMATION ABOUT THE COMPANY
- ❖ FINANCIAL RESULTS FOR 1ST QUARTER 2016
- ❖ OTHER INFORMATION



INFORMATION ABOUT THE COMPANY



Details about the company

Company name

- Stock Company Klaipedos nafta

Company code

- 110648893

Authorized share capital

- EUR 110,231,170

Registered address

- Buriu str.19, P.O. Box 81, 91003 Klaipeda-C, Lithuania

Mailing address

- Baltijos ave. 40, LT-93239, Klaipeda, Lithuania

Telephone

- +370 46 391772

Fax

- +370 46 311399

E-mail

- info@oil.lt

Website

- www.oil.lt, www.sgd.lt

Legal – organisational form

- Stock company

Date and place of registration

- 27 September 1994, State Enterprise Centre of Registers



Mission

Ensure reliable and effective supply of LNG and transshipment of oil products

Vision

Reliable operator of oil products and LNG terminals that adds value through implemented projects and balanced expansion

Values

Proactivity

Transparency

**Professionalism
and reliability**

**Social
Responsibility**

Diversified activity of the Company



Oil terminal



LNG terminal



Subacius fuel base



LNG small scale

LNG consultations

New projects



Oil terminal characteristics



Railway

2 tracks for light oil products - LFO (total 60 tank-cars)

2 tracks for heavy oil products - HFO (total 64 tank-cars)

One of the track is universal: can load both HFO and LFO

Two four-track railway trestles provide a possibility to discharge or load 124 tank-cars simultaneously.



Storage tank farm

Total 28 tanks

~ 450 thousand cbm storage capacity

Biological Waste Water Treatment Facilities

Waste water collected and treated annually up to 400 cub. m thousand (160 m³/h)



2 Jetties

Depth: 14 m

Length: 270 each

Harbour entrance depth: 14.5 m

Tanker batch: up to 100,000 t with 12.5 m allowable draught



Auto tankers loading system

Service to import gasoline and diesel by tankers for the Lithuanian market needs

4 loading points at the same time

LNG terminal infrastructure

- LNG floating storage and regasification unit – FSRU, 170,000 thousand cbm
- Jetty 450 m length
- Pipeline 18 km
- Gas metering station in Kiskenai, Klaipėda distr.

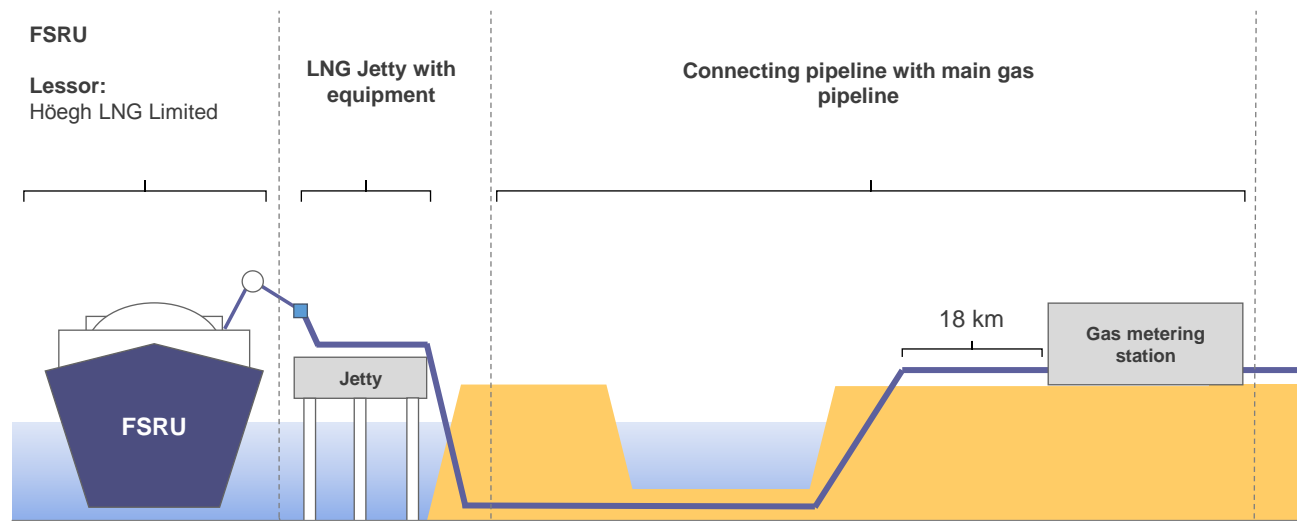

Subacius fuel base infrastructure



- Park of storage tanks (66 units, 338 thousand cbm), adapted for storage of light oil products;
- Rail trestle (simultaneously handle 14 rail tanks);
- Modern loading station of auto tank-cars;
- Other necessary equipment (modern laboratory, mobile fire extinguishing equipment, sewage cleaning equipment and etc.).





FINANCIAL RESULTS FOR THE 1st QUARTER 2016

Revenue, EBITDA, Net profit



Revenue, MEUR

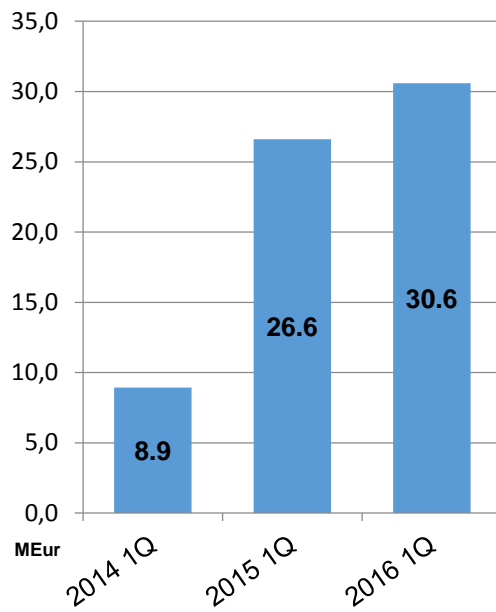

EBITDA, MEUR

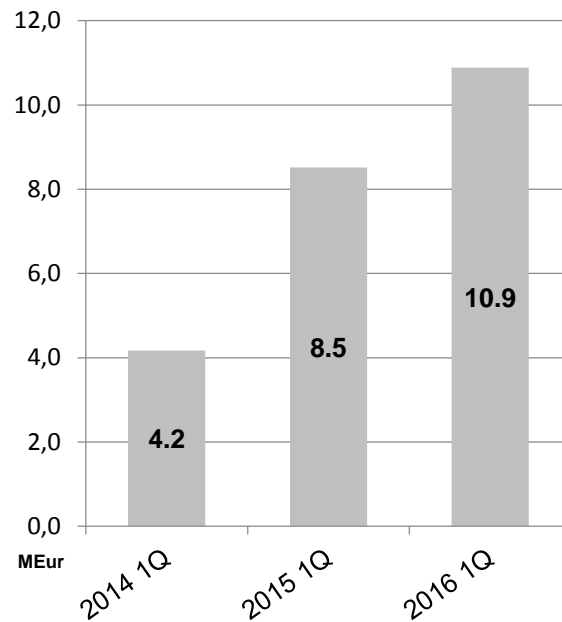

Net profit, MEUR

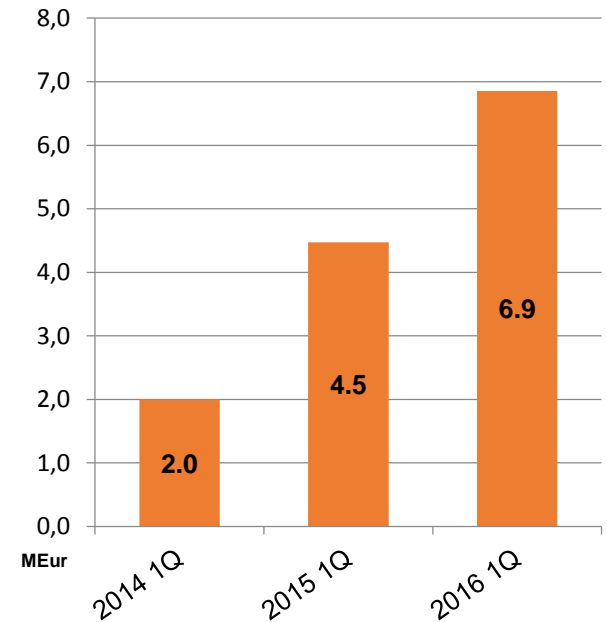

Financial figures (unaudited)



MEUR	2015 Q1	2016 Q1	Change, %
Sales Revenue	26.6	30.6	15%
Gross profit	6.6	8.9	35%
EBITDA	8.5	10.9	28%
Profit before taxation	5.2	7.6	46%
Net profit	4.5	6.9	53%
Gross profit margin	24.8%	29.1%	-
EBITDA margin	32.0%	35.6%	-
Net profit margin	16.9%	22.5%	-
Return on equity (ROE)*	6.8%	24.0%	-
Return on assets (ROA)*	5.4%	18.8%	-
Profit per share (EPS), EUR/share	0.012	0.018	50%
Average number of shares	380,606,184	380,606,184	-

* Ratios are calculated for the last 12 month period.

Structure of Revenue & EBITDA based on operating segments



Sales revenue Q1 2016, MEUR

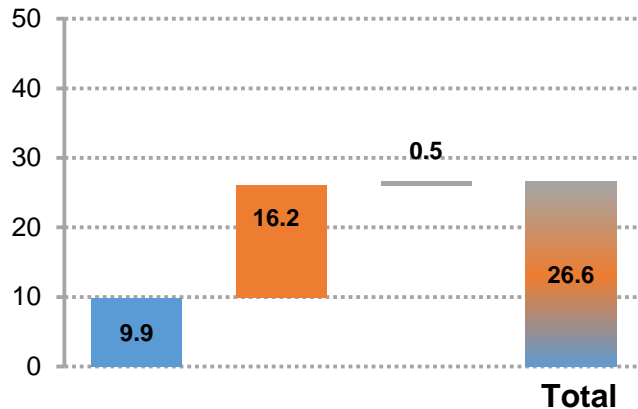

Sales revenue Q1 2016, MEUR

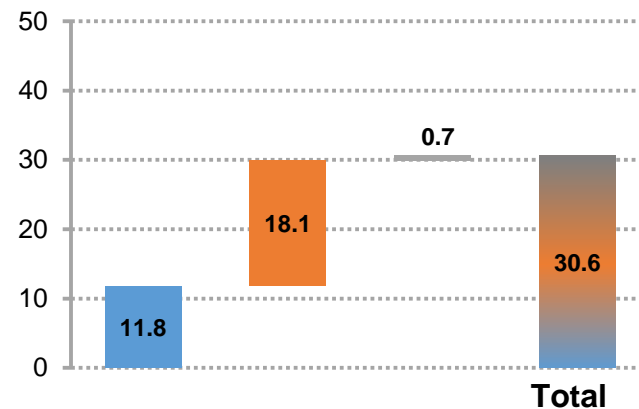

EBITDA Q1 2015, MEUR

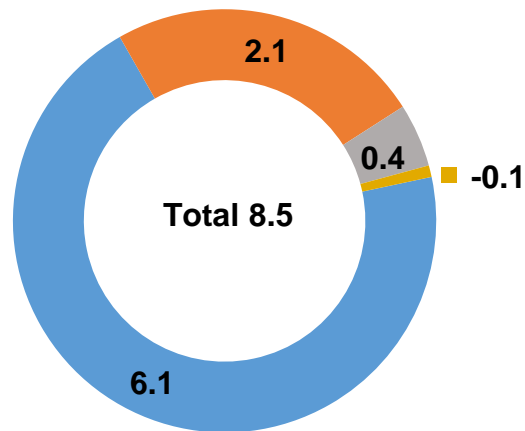

EBITDA Q1 2016, MEUR

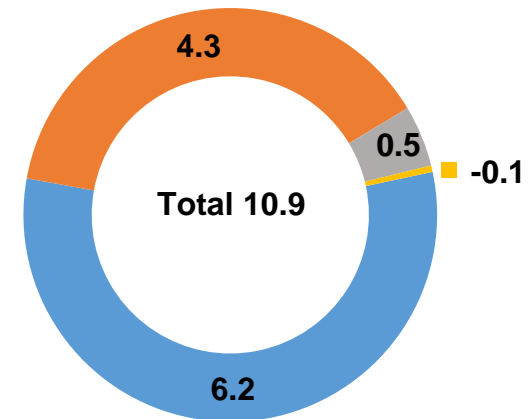

- Oil Terminal
- LNG terminal
- Subacius fuel base
- LNG small scale terminal



Oil terminal results for Q1 2016

MEUR	Q1 2015	Q1 2016
Revenue	9.9	11.8
Net profit	3.8	4.1
EBITDA	6.1	6.2

Facts of periods comparison:

- Orlen Lietuva AB total transshipment volumes increased by 54 per cent;
- Transit heavy oil products transshipment flows increased by 73 per cent;
- Transshipment of light oil products from Byelorussia increased by 43 per cent.

Revenue & EBITDA

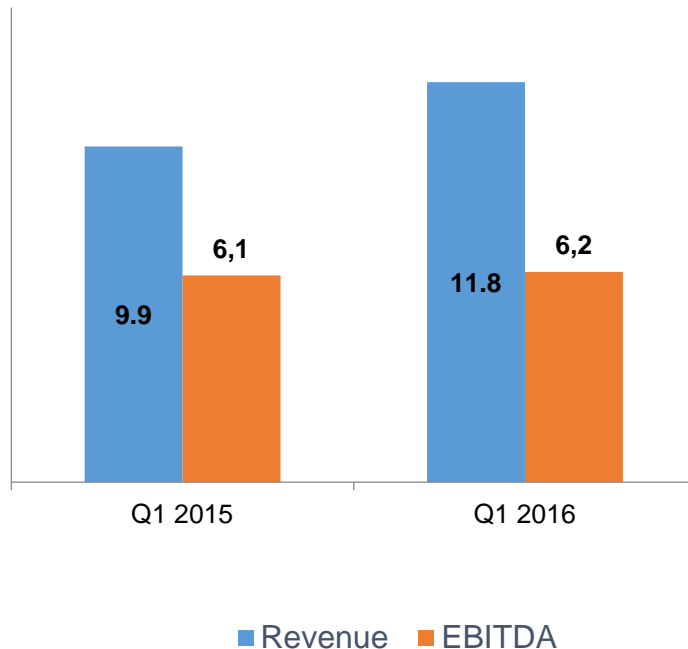

Transshipment, thousand tons

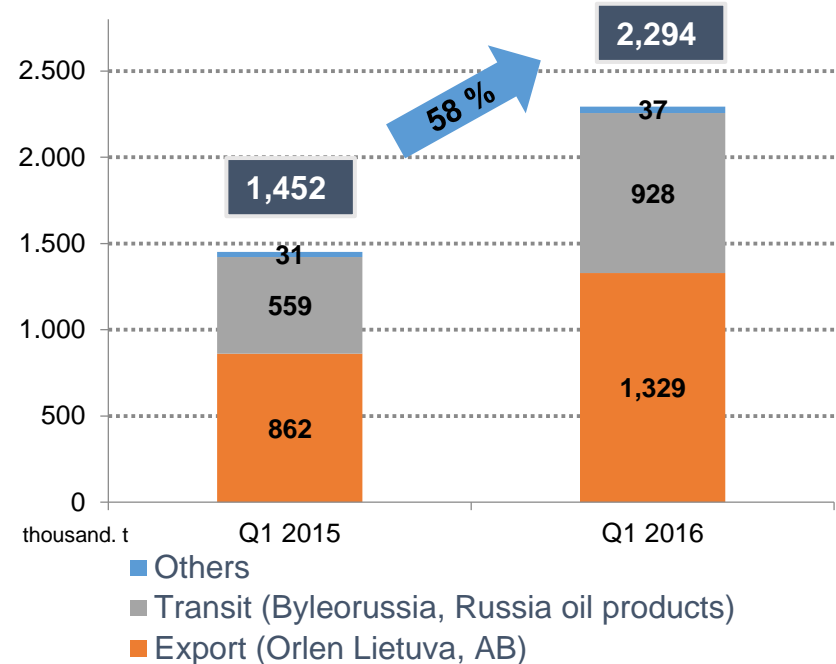

AB Klaipėdos nafta oil product transshipment Q1 2014-2016

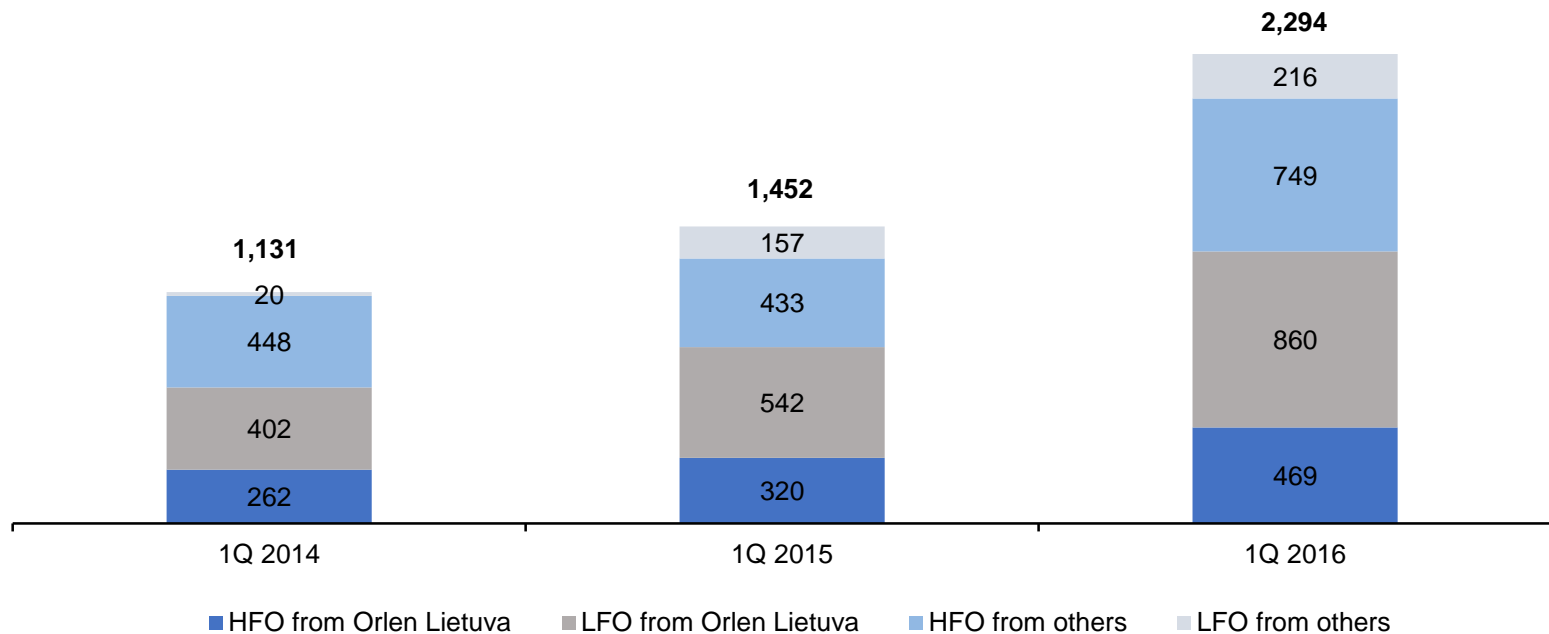

Facts of periods comparison:

- Compared to 1st quarter 2015, in 1st quarter 2016 the transshipment of light oil products of ORLEN Lietuva AB increased by 59 per cent (318 thousand t.)
- 1st quarter 2016 all transshipment of ORLEN Lietuva AB amounted 58 per cent of all terminal transshipment flows (in comparison 1st quarter 2015 – 59 per cent);
- Compared to 1st quarter 2015, in 1st quarter 2016 the transshipment of transit (Byelorussia) heavy oil products increased by 73 per cent or by 315 thousand tons.

Subacius fuel base results for Q1 of 2016

MEUR	Q1 2015	Q1 2016
Revenue	0.6	0.7
Net profit	0.2	0.3
EBITDA	0.4	0.5

Facts of periods comparison:

- 1st quarter 2016 the transshipment in Subacius fuel storage base amounted 26 thousand tones (2015 – 47 thousand tones).
- 1st quarter 2016 sales revenue from the Gunvor contract amounted EUR 160 thousand.

Revenue & EBITDA

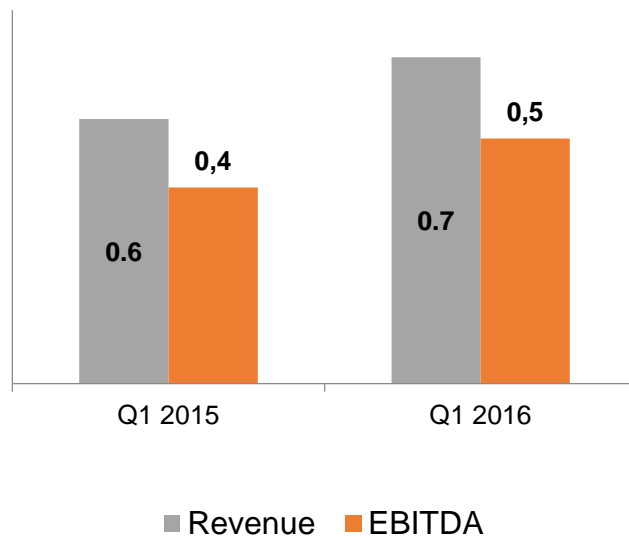

Average storage volume, thousand tons

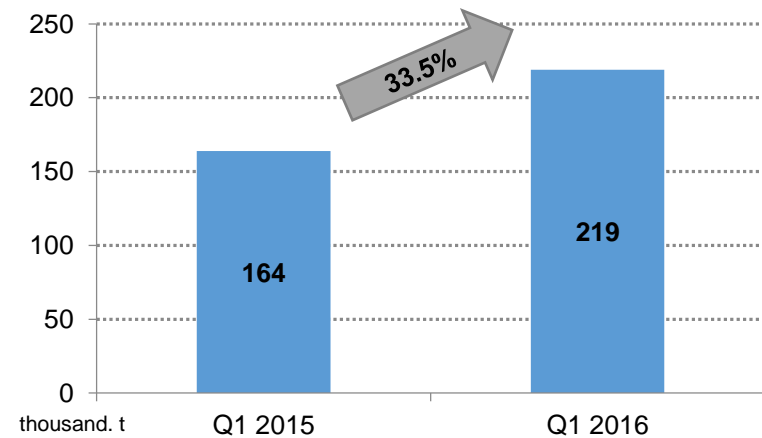



LNG terminal results for Q1 2016

MEUR	Q1 2015	Q1 2016
Revenue	16.2	18.1
Net profit	0.6	2.8
EBITDA	2.1	4.2

*The LNG terminal activity profit is regulated in terms as set by the laws. Actually foreseen the net profit for the LNG activities for the year 2016 shall amount EUR 4.5 million. Additionally received amount shall be dedicated for the LNG terminal required expenses for the coming financial periods.

Facts:

- During 1st quarter 2016 5 LNG carriers accepted, which delivered 311.7 thousand tons LNG;
- 5,088 thousand MWh natural gas re-gasified and supplied to the gas transmission system (+263.7%);
- 1st quarter 2016 LNG terminal users: LITGAS UAB, Lietuvos dujų tiekimas UAB, Achema AB.

Revenue & EBITDA margin

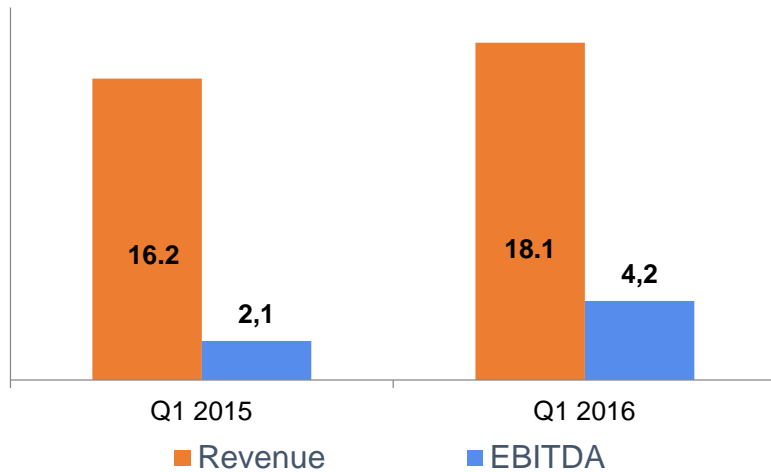

Re-gasification, MWh

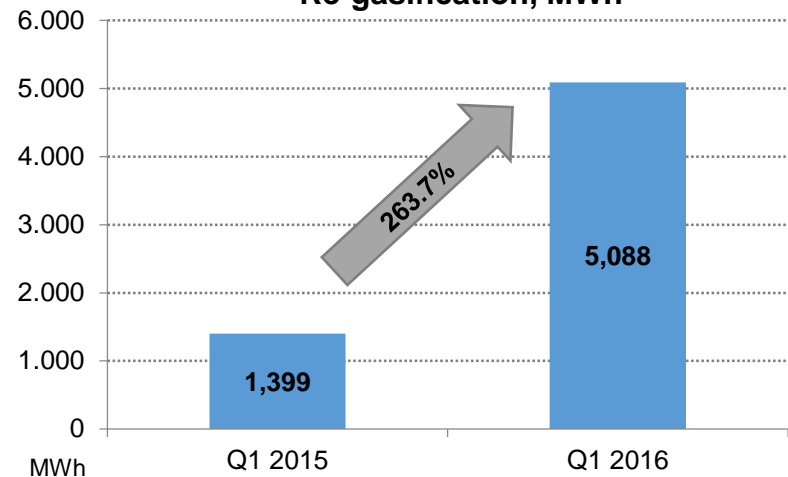



Company's Balance sheet

Assets, EUR thousands

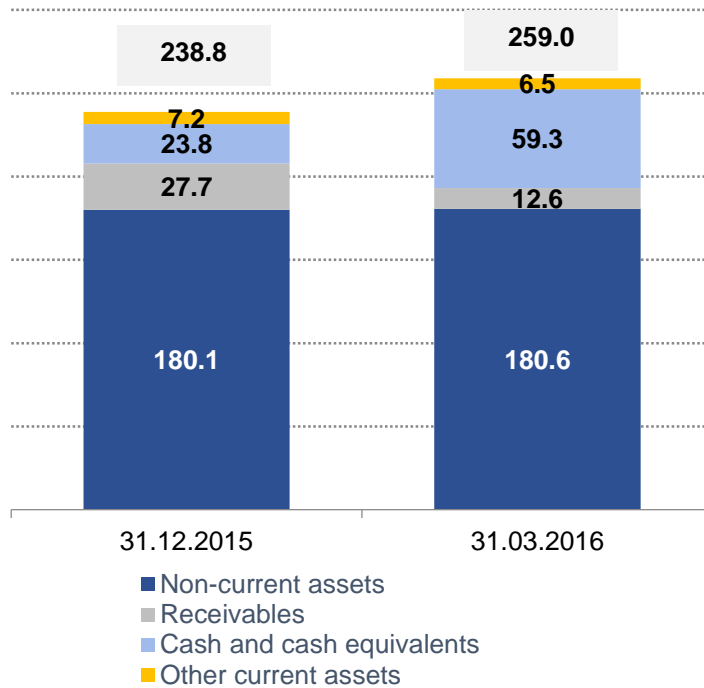

Equity and liabilities, EUR thousands

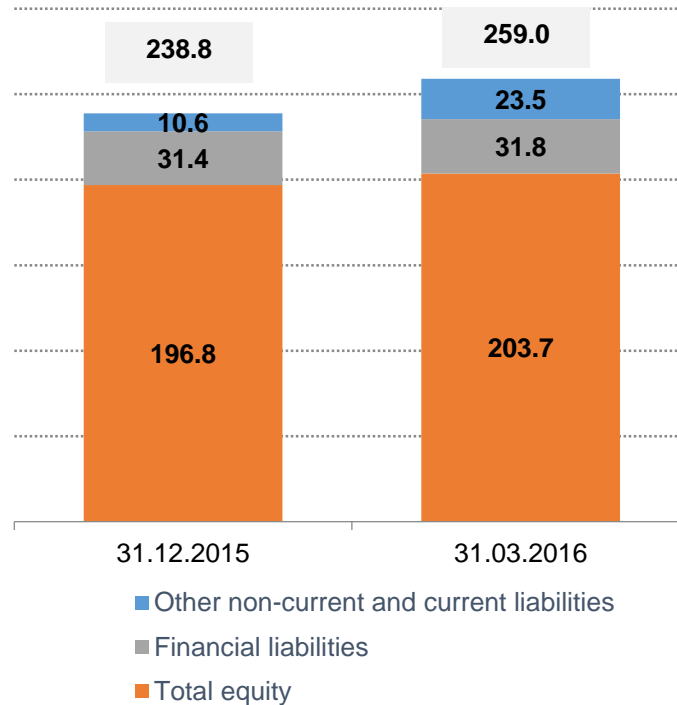

- **Non-current assets** comprise 69.7 per cent of total assets (31-03-2016);
- **Total equity** amounted to 78.6 per cent of total assets (31-03-2016);
- Total assets has increased by 8.4% and comprise EUR 258,952 thousand.

LNG small-scale reloading station investments

LNG small-scale reloading station project development events:

- **On the 12th February 2016** the EPC (Engineering, procurement and construction works) contract was signed with the consortium, consisting of Lithuanian – German company PPS Pipeline Systems GmbH and Czech company Chart Ferox, a.s.

Key highlights of EPC contract:

- Investments in 2016-2017 foreseen EUR 27.7 millions;
- It is planned that the partial operation of the reloading station will commence in 15 months after the date of entering into effect of the contract and all the works will be completed in autumn of 2017.
- The planned maximum capacity of the LNG small-scale reloading station is about 5,000 m³;

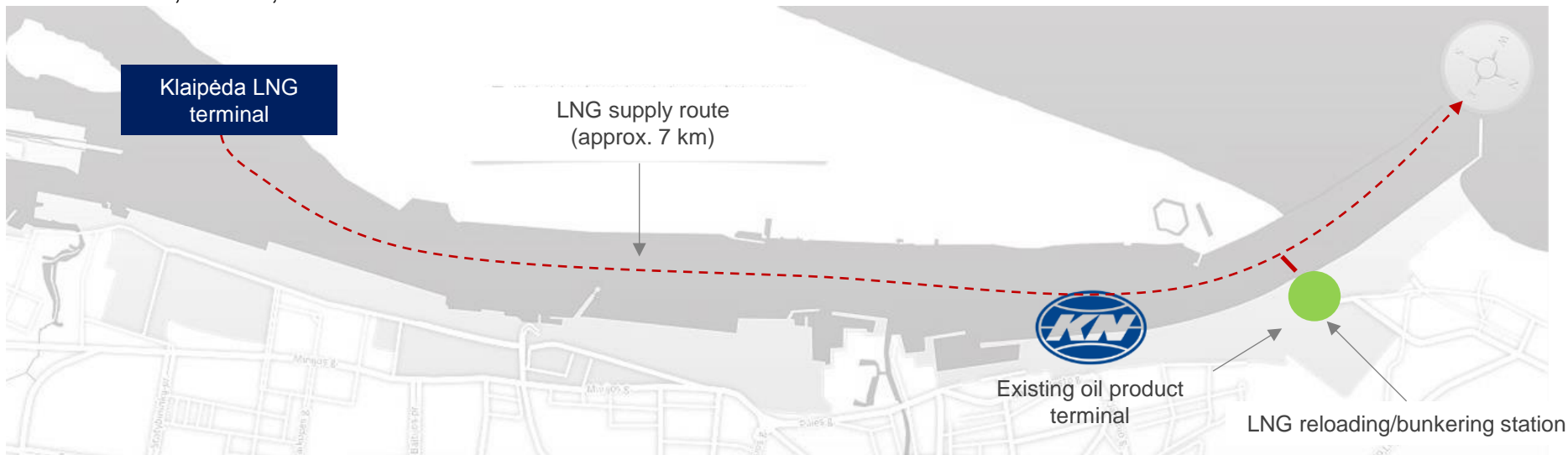
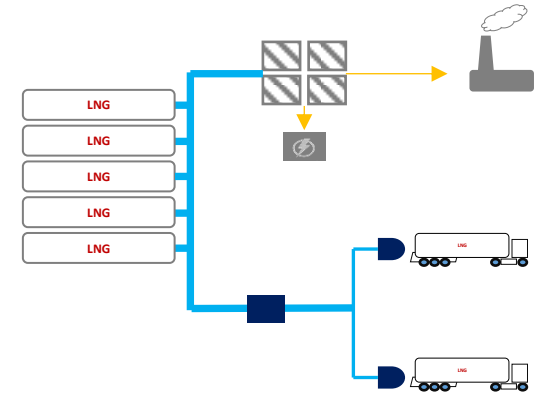

Oil terminal investment projects

The infrastructure expansion plans in the Company's oil terminal territory:

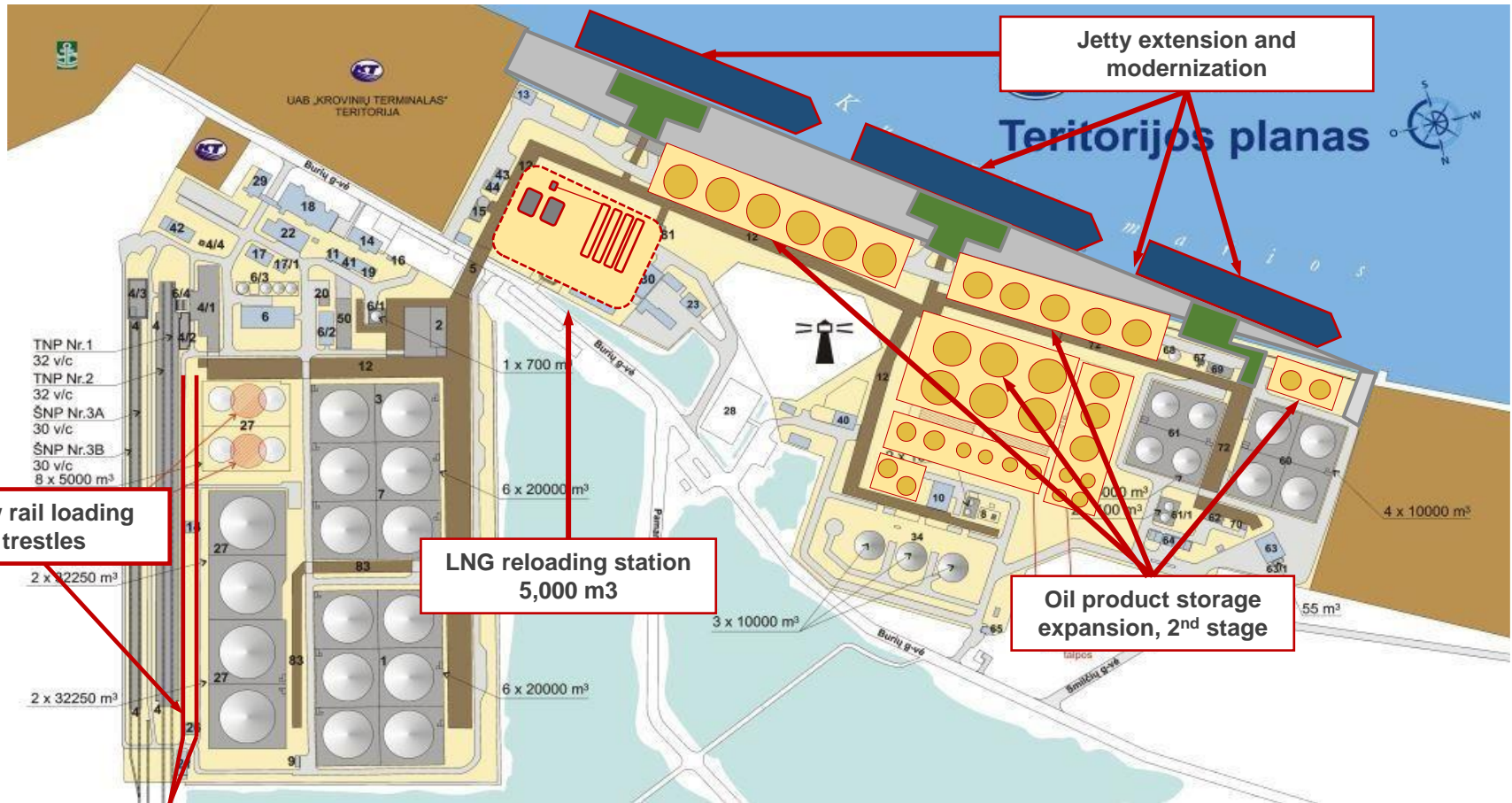



Company's investments, EUR thousand

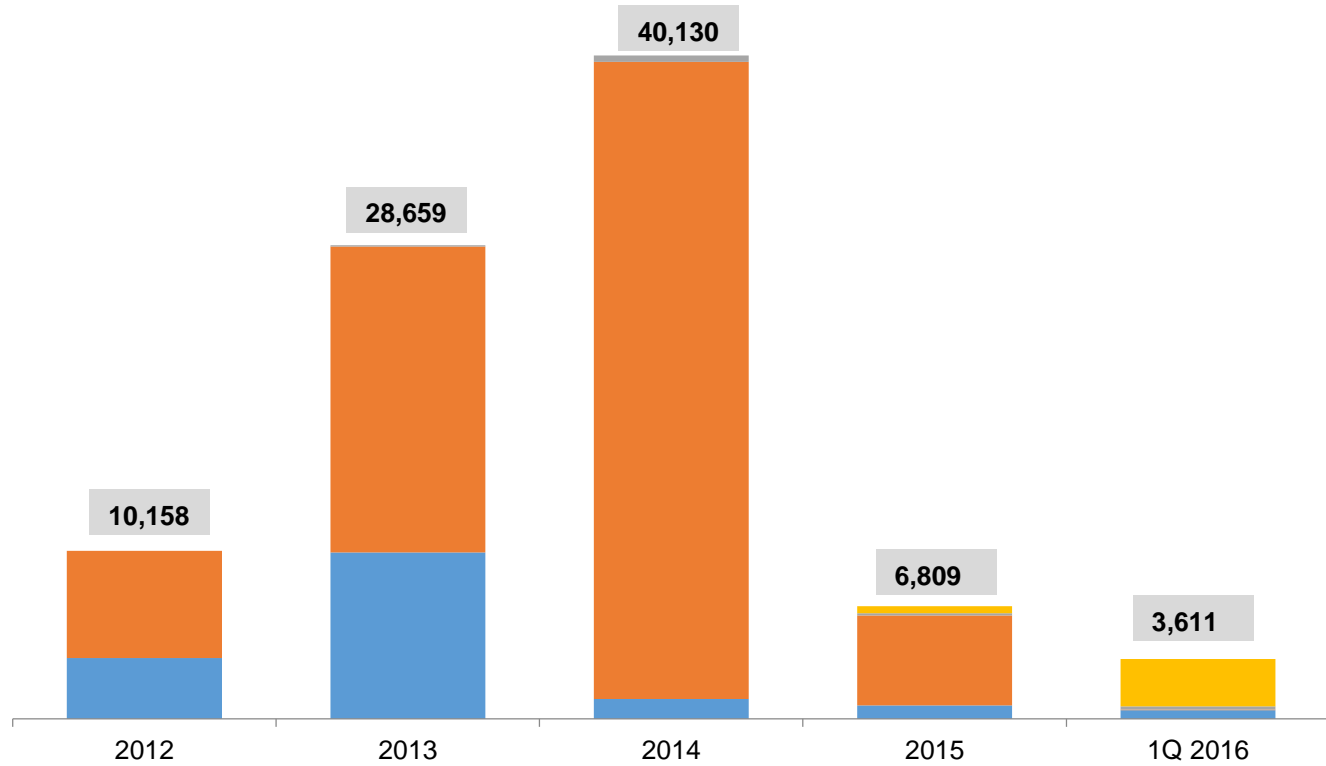

■	LNG small scale	-	-	-	429	2,858
■	Subacius fuel base	-	81	375	142	200
■	LNG terminal		18,513	38,572	5,429	38
■	Oil terminal	3,665	10,065	1,183	809	515

OTHER INFORMATION

Shareholders and shares



Since 2003 the shares of the Company are listed on **NASDAQ OMX Vilnius** stock exchange:

- ISIN code – LT0000111650
- Abbreviation – KNF1L

As at 31 March 2016 all the shares of the Company were owned by 1,903 shareholders (on 31 December 2015 – 1,847)

Shareholder's name (company's name, address, company code of registration)	31 st of March 2016		31 st of December 2015	
	Number owned shares (unit)	Part of authorized capital (%)	Number owned shares (unit)	Part of authorized capital (%)
The Republic of Lithuania, represented by the Ministry of Energy of the Republic of Lithuania (Gediminas Ave. 38/2, Vilnius, 302308327)	275,241,290	72.32	275,241,290	72.32
Concern SC Achemos grupe (Jonalaukis village, Jonava district, 156673480)	38,975,150	10.24	38,975,150	10.24
Other (each owning less than 5%)	66,389,744	17.44	66,389,744	17.44
Total	380,606,184	100.00	380,606,184	100.00

Trading in KNF1L shares on Nasdaq Vilnius stock exchange in January - March 2016

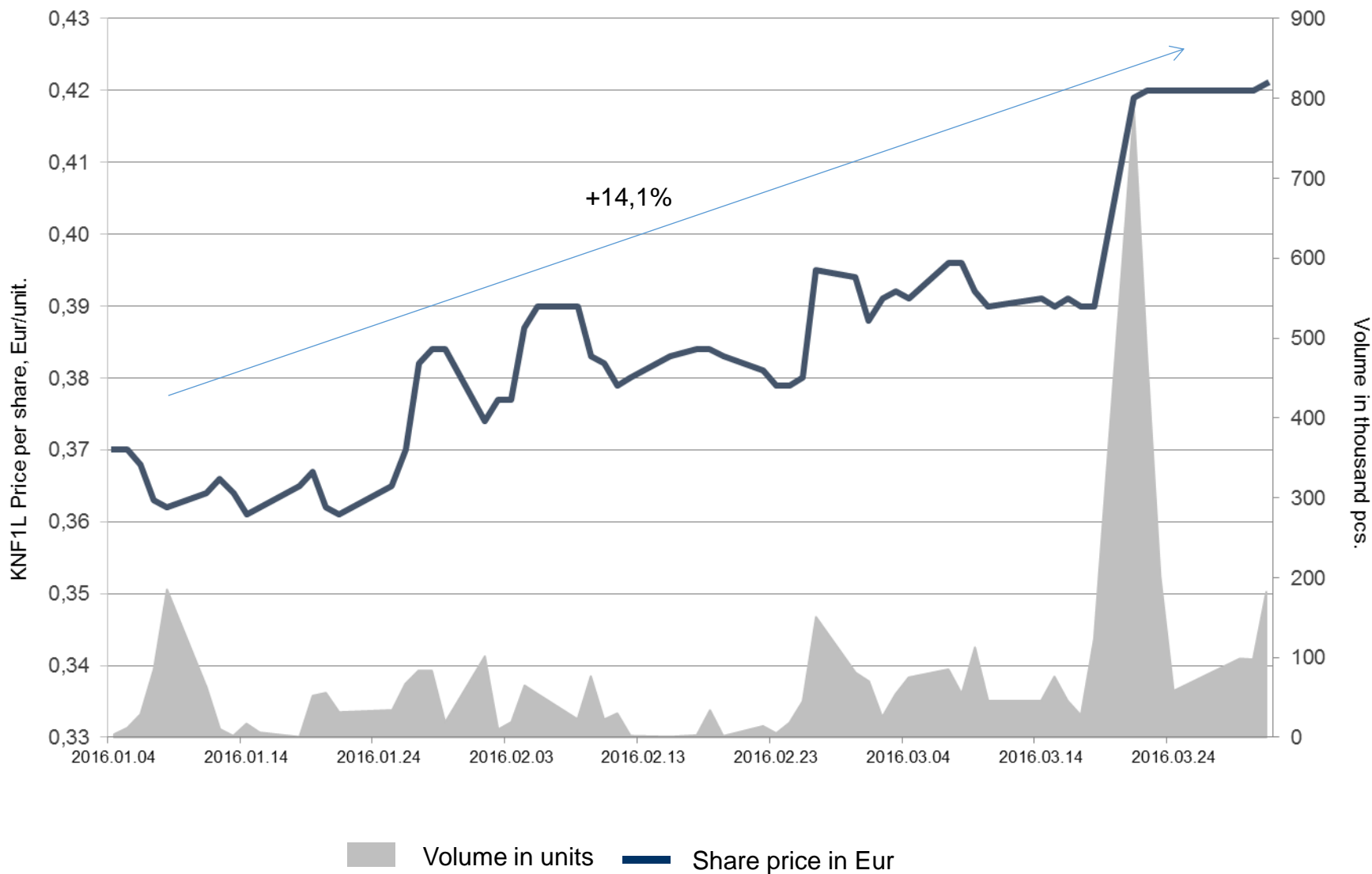

KNF1L share price and Nasdaq Vilnius indexes comparison in January – March 2016

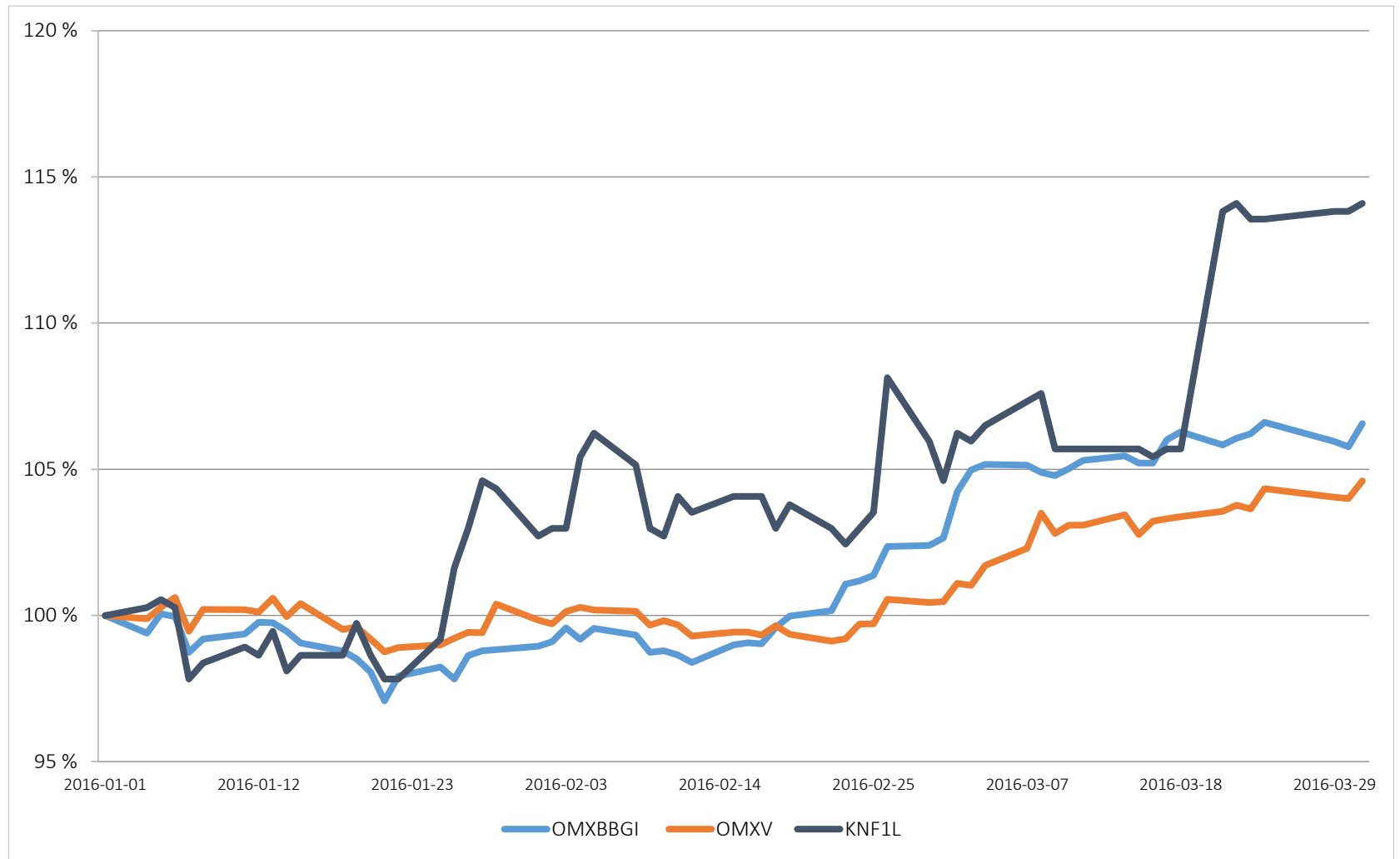

Significant events of 1st quarter 2016



- **January 5th 2016.** Klaipėdos nafta AB and the Swiss-registered company Verum Plus AG has signed a long term transshipment contract on provision of heavy fuel oil products transshipment services in Company's terminal. The term of the Contract is until 31 December 2016, with an option to extend it for one more year.
- **February 4th, 5th 2016.** The Company has signed Terminal Usage Agreements with Lietuvos dujų tiekimas UAB and Achema AB. Both contracts is valid until the 30th of September 2016.
- **February 12th 2016.** Consortium of PPS Pipeline Systems GmbH and Chart Ferox, a. s and SC Klaipėdos nafta concluded EPC (Engineering, procurement and construction works) contract whereby the Consortium undertook to complete all the works according to the contract on a lump sum amount of 27.7 mln. EUR excluding VAT.
- **March 8th 2016.** The extraordinary general meeting of shareholders approve the decision of the Board of Klaipėdos Nafta AB to implement liquefied natural gas distribution station investment project for the total price not exceeding EUR 27,700 thousand (without VAT).
- **March 21st 2016.** Company has submitted the application and related documents to Nasdaq Vilnius AB regarding the listing of Company shares in the Main List. **April 4th 2016** Nasdaq Vilnius AB listed Company's shares in to the Main List.
- **April 26th 2016** ordinary general meeting of shareholders of the Company was held which approved the audited financial statements for the year 2015 and appropriation of profit (loss). EUR 17,6 million allocated for the dividends.
- **May 2nd 2016.** SC Klaipėdos nafta published Corporate social responsibility report. It is prepared for the first time and publicly announced Company's as social responsibility activities.

- **Publicness.** Klaipėdos nafta AB published investors calendar and will further report Company's interim results.
- **LNG Cluster.** Company signed LNG Cluster founding and joint operational contract. LNG cluster unifies science, studies and business potential for common activity.
- **Support for LNG studies.** Klaipėdos nafta AB will finance 8 LNG terminals engineers bachelor study places.



Employees of the Company



	Q1 2015	Q1 2016	Change	
			+/-	%
Average number of employees in categories	369	366	-3	-0.8%
Managers ¹⁾	37	36	-1	-2.7%
Specialists	133	153	20	15.0%
Workers	199	177	-22	-11.1%

	Q1 2015	Q1 2016	Change	
			+/-	%
Average gross monthly salary²⁾	1,469	1,658	189	12.9%
Managers ¹⁾	3,339	3,684	345	10.3%
Specialists	1,578	1,661	83	5.3%
Workers	1,071	1,266	195	18.2%

Remarks:

- 1) The Company's managers include: General Manager, Deputy Manager, Heads of Departments and their deputies, Heads of Deputies;
- 2) The average monthly salary is calculated in accordance to average monthly wage calculation procedure as stated in the State companies' employees' average monthly salary calculation procedure approved by the Lithuania Government on 23 August 2002, resolution No. 1341 and their changes.

Organizational structure of Klaipedos nafta AB

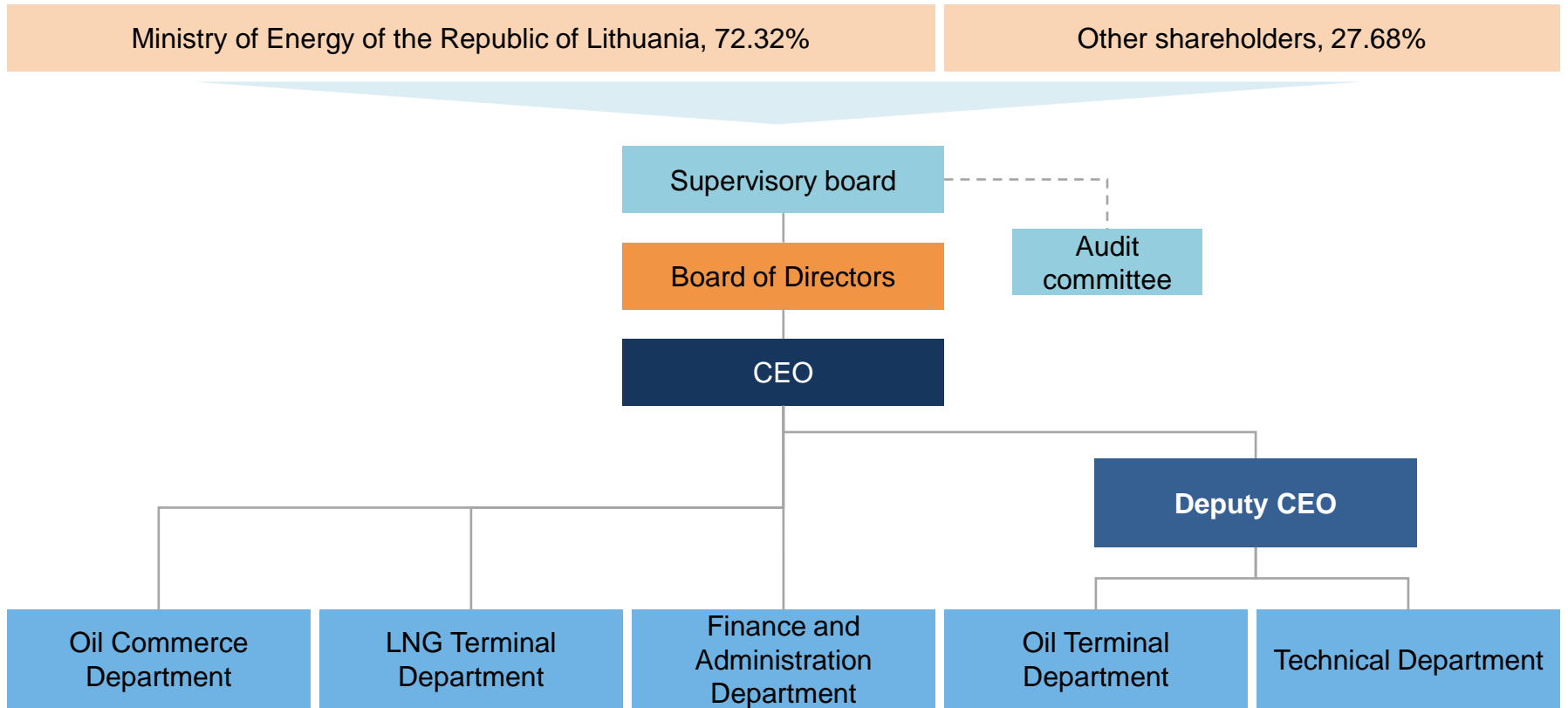

Members of the Board of the Company



Rytis Ambrazevičius

Independent Member of the Board of the Company. Elected as the Board member by the Supervisory Board on 24 October 2011. The Supervisory renewed the mandate on 29 April 2014 for 4 years or until the time, when the new Board is elected and starts acting.



Mindaugas Jusius

Independent Member of the Board of the Company. Elected as the Board member by the Supervisory Board on 24 October 2011. The Supervisory renewed the mandate on 29 April 2014 for 4 years or until the time, when the new Board is elected and starts acting.



Dainius Bražiūnas

Member of the Board of the Company. Elected as the Board member by the Supervisory Board on 25 August 2014 until the term of office of the acting Board of Company.



Mantas Bartuška

Member of the Board of the Company, General Manager. Elected as the Board member by the Supervisory Board on 25 September 2014 until the term of office of the acting Board of Company.

- There is no permanent Chairman of the Board elected, therefore, the Chairman of the Board is elected from the Board members every meeting by ad hoc principle.

Management of the Company



Mantas Bartuška
General Manager



Gediminas Vitkauskas
Director of the Oil terminal department



Osvaldas Sabaliauskas
Deputy General Manager



Tadas Matulionis
Director of the LNG terminal
department



Marius Pulkauninkas
Director of Finance and Administration
Department



Darius Šilenskis
Director of Oil Commerce department



Genadijus Andrejevas
Director of Technical Department



Thank you for attention

Klaipėdos nafta AB

Registered address - Burių str. 19,
LT-91003; Klaipėda
Lithuania

Mailing address - Baltijos ave. 40,
LT-93239, Klaipėda,
Lithuania

Tel. +370 46 391772

Fax +370 46 311399

www.oil.lt, www.sgd.lt